

Die-Cutting Machines

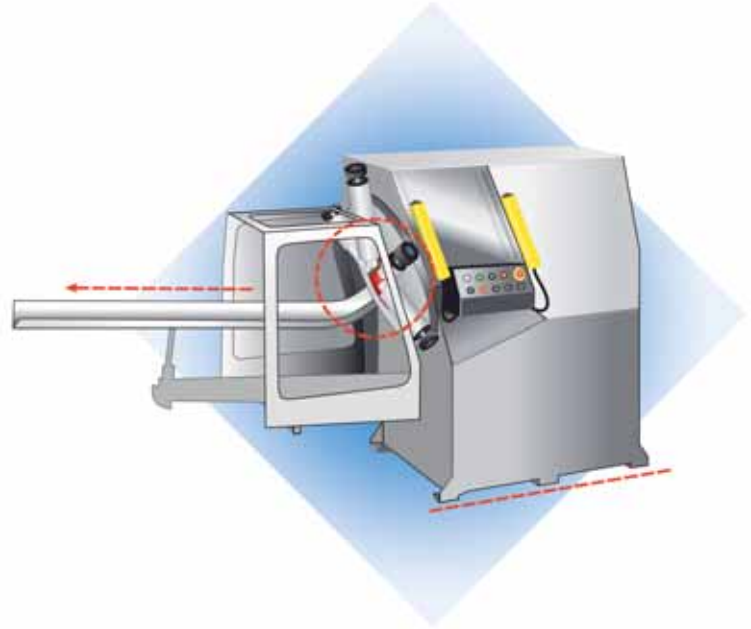

Die-Cutting Machines

Die-Cut Shapes



Top quality – Made in Germany



Flexibility and versatility with BUSCH Die-Cutting Machines

The design and production of a label is an expensive process. Material and layout have to achieve a high visual effect and the die-cut shape plays a vital role in attracting attention. A label, a brochure or a children's booklet with a shape enhances the sales effect. The scope of shaping is wide, from almost simple forms with rounded or cut corners to complicated fancy contours. The material used is often difficult. To meet these new challenges we offer a suitable solution for each individual requirement – for small, medium or large runs.

BUSCH die-cutting machines are noted for their safe operation, short set-up times and maintenancefree operation.

BUSCH's top priorities are quality and efficiency. All machines are regularly checked and carry the CE and GS label as standard.

BUSCH has been manufacturing and supplying extremely solid and durable die-cutting machines worldwide since the beginning of the 1960s.

Decades of attention to detail has led to regular improvements in the quality of the machines. The BUSCH concept confirms their precision, efficiency and high product diversity for die-cutting.

Contents

Top quality	
– Made in Germany	2

What is produced on the machine?	
– Products	4
– Material	4
– Types of die-cutting	4

How it works	
– The die-cutting process	6
– Die-cutting with counter-pressure	7
– Production methods for different types of die-cutting	8

Cutting dies	10
--------------	----

Model overview	12
Models A, A+P, AL	12
Models B, B+P	14
Models BL, BLS	16
Model CL	18

Ancillary equipment	20
---------------------	----

Technical data	22
----------------	----



What is produced on the machine?



Products

These are just some of the wide range of items produced. Labels are, of course, the most important.

Labels of all sorts

Large-sized labels for tins and jars

Inmould labels

Stitched, folded and glued brochures

Passports

Children's booklets

Credit and loyalty cards

Playing cards

Plastic flower and plant stickers

Ice cream covers

Wrappers for chocolate

Tags for clothing and luggage

Glued note pads

Sticky notes



Material for die-cutting

Paper, board and all related material, different plastics and plastic laminates, PP- or PE-foil, self-adhesive foil, tempered and varnished aluminium foil, etc.



Types of die-cutting

The machine processes pre-cut, plus folded, stitched or glued stacks of material.

- Full-cut of complete outer contour
- Corner rounding
- Corner cut
- One and two-sided cut
- Three-sided cut of brochures, passports, children's booklets
- Two-up cut of small-sized products
- Die-cutting in a two-up system
- Four-sided cut of folded quires (for sheet separating)

(See also page 8-9)

Product diversity,
Flexibility,
Efficiency

This is what
makes
the difference –

BUSCH die-cutting
machines in premium-
quality casting

- with high damping characteristics
- with an optimal torsionally-rigid design principle for high punching power
- with high durability



Machine body with punching ram
in casting design



The machine body is manufactured in grey cast iron (EN-GJL); the ram, feeding tray and clamping arms (except A series machine) in nodular cast iron (EN-GJS).

The casting design of all BUSCH die-cutting machines guarantees perfect parallels of cutting die, punching ram and cutting material, which is important if high punching power is required. All this ensures production with very tight tolerances.



Cutting die

How it works

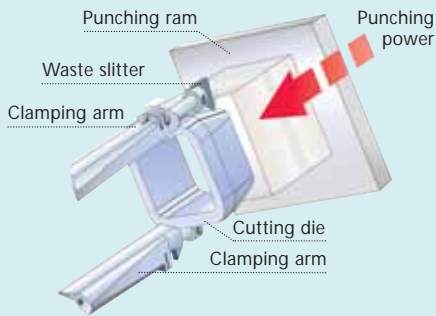

The die-cutting process

The ram-type machines work by pushing the material through the die to create the required shape. Square-cut stacks of printed material are placed in the feeding tray, between the cutting die and the punching ram. After release, the hydraulically operated ram pushes the material almost horizontally through the die onto the delivery tray in one stroke. The die is manufactured by die makers according to the required shape. The one-way system ensures tight tolerances, as the material is inserted directly in front of the die - protected by safeguarding systems. The so-called 'sagging' of stacks is minimised, as the cutting direction of the upright standing stack is slightly inclined.



Feeding tray with stack of material

The material can be zero-punched, where the whole stack is punched or, alternatively, a small quantity of material can be left in front of the die which is punched with the next stroke. This gives a longer die life. A soft PP-backing plate on the ram protects the cutting edge of the die when zero-punching. The punching stroke is released by light barriers or by controlled protection doors – depending on the model.

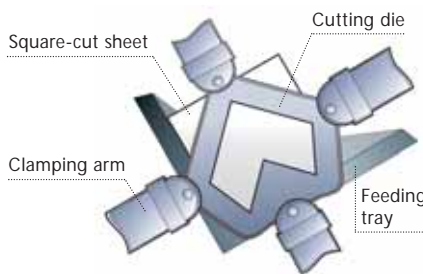

Two-side aligning system

The two-side aligning system offers the great advantage that only the two lower surfaces of the feeding tray are used for alignment. This offers an even wider range of products which can be die-cut.

The operator determines the working speed, as the machines are not controlled by a fixed rhythm. Once the material is inserted and aligned the punching stroke is released; idle strokes are thus avoided.

The size of the finished article can be from 10x10 mm up to 330x380 mm. The required size and the speed of output will determine the optimum model of die-cutting machine.

The small waste margin of 0-3 mm ensures maximum productivity. The waste margins are removed by waste slitters and fall away under gravity towards the waste outlet; it cannot pile up. For the positioning of waste slitters two options are possible. Either the die maker screws the waste slitters on to the outer side of the die, with the exact positions being defined by the punching requirements. Or the waste slitters supplied with the machine are fitted separately into the flexible clamping arms of the machine at any required point.

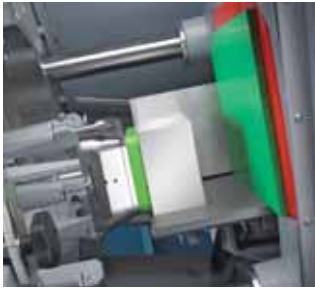

Feeding tray with stack of material

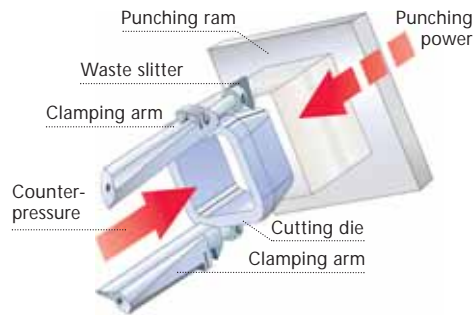

Die-cutting with counter-pressure

Counter-pressure is required for minimising tolerances

- when die-cutting embossed paper and plastics (PP or PE foil) for inmould labels and similar articles to counteract stretching or movement of the material during the die-cutting process
- when tight tolerances are required
- when cutting large-sized labels of difficult material
- for 4-sided cut of folded quires (sheet separating for diaries)
- when die-cutting tempered and varnished aluminium foil

The counter-pressure units are powerful and user-friendly, and are available as an option for each model of die-cutter. Retrofitting is done easily in 30 minutes. Each BUSCH die-cutting machine has the great advantage of being able to operate with or without counter-pressure, according to the requirements.

The pneumatic mobile counter-pressure units for models B, B+P, BL, BLS and CL can be retrofitted and wheeled up to the die-cutter in place of the delivery tray. For A series machines the unit is easy to fit onto the support of the delivery tray. The unit is connected to a compressed air supply.

The die is especially manufactured for counter-pressure die-cutting, with a matrix of plastics or aluminium inside the die, exactly matching the die shape.

The material to be cut is placed in front of the die with the projecting matrix. When the hydraulic pressure is activated the counter-pressure holds the material vertically in front of and inside the die for minimising tolerances. After reaching the end of the punching stroke, the finished material is pushed back into the feeding tray by the pneumatic counter-pressure cylinder. The die-cut material is then removed from the feeding tray. This reduces the throughput of the machine by half.

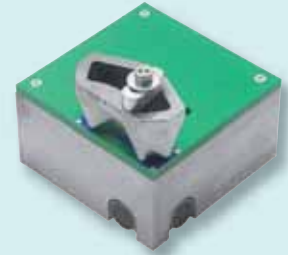
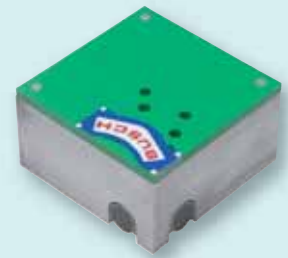

An aluminium die positioning block is supplied to set up each job quickly off-line. A few manual tasks are necessary to prepare a new job. A square-cut sheet is fixed to the block, flush with the edges. The die is placed on the cutting line and fixed to the positioning block. Then the block with the die is placed in the feeding tray of the machine, held by lateral magnets. The clamping arms can then be fastened onto the die, after which the block is removed from the feeding tray. The set-up time is just 15 minutes! Further fine adjustments – also possible during the die-cutting process – achieve a perfect performance.



Production methods for different types of die-cutting



Die-cutting pads with a bevelled edge

A pad with a sloping edge – an eye catcher on your desk! The print on a standard note pad or sticky note pad remains visible to the last sheet. A newly-designed device, fitted to the punching ram, carries out the bevelled edge cut of a printed pad. The bevelled edge may be straight or formed. The integrated pneumatics tightens and turns the pad before the cutting stroke. This ancillary device is available for each new BUSCH die cutter (except A series machines) and offers a wide range of formats and angles.

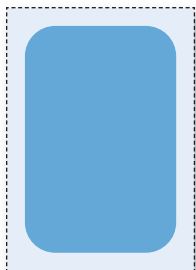

Full-cut

Full-cut of the complete outer contour is used for labels of all sorts, credit and loyalty cards, highquality playing cards, plastic flower and plant stickers, etc. The image shows the blank with the waste margin.

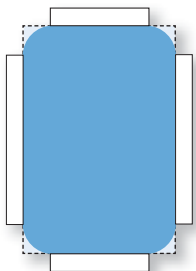

Corner rounding and corner cutting

Corner rounding and corner cutting without a waste margin is used for reasonably priced card systems, books and brochures (saving on material). The cutting die is manufactured with guide surfaces on those sections where no cut is made.

Die-cutting children's booklets and brochures

Three sides of the stitched or glued product are die-cut to a shape. The cutting die is manufactured with a guide surface for the stitched or glued side, as this side is not cut. The die for a folded brochure like the example below has two guide surfaces.





Die-cutting in a two-up system

For saving on material the pre-cut sheet contains two printed labels, e.g. detergent or food labels. The prints are laid-down interlocked, the second print turned through 180°. The distance between the prints shows the normal waste margin! Waste

slitters are positioned in such a way that the waste of the first print is cut off and falls down easily. The cutting process is carried out in two steps.

The label stacks, fed into the machine, contain approx. 1000 sheets. The lower positioned print is completely cut with the first step, whilst the upper print is separated and moved over the die onto a special holding device fitted at the feeding tray.

The upper print is then removed manually from the holding device, turned through 180° and fed into the machine for the second cutting step. The cutting die remains unchanged in its position.

This procedure is possible on BUSCH die-cutters, as the machine design requires pre-cut stacks with just one square-cut part, which is fed into the 90° angle of the feeding tray. The two-up system allows the use of normal punching dies, 60-90 mm high. Using this system printers can achieve savings on material of approx. 20 % and a reduction in guillotining time of approx. 50 %. For this die-cutting process we recommend our machine model BL or BLS.

Two-up cutting of small-sized products

The handling of very small label stacks – like our ‘cheese wedge’ example – is a most difficult action on the guillotine as well as on the die-cutter, as it is difficult to grip such small, high stacks. A larger sheet containing two label prints can be handled more easily – in stacks of normal height.



The cutting die for our label example is manufactured with a 7 mm long middle bridge positioned between the prints. The two ready cut label rows run separated onto the delivery tray. This method offers simplified handling, double throughput of the machine and saving on guillotining cost.

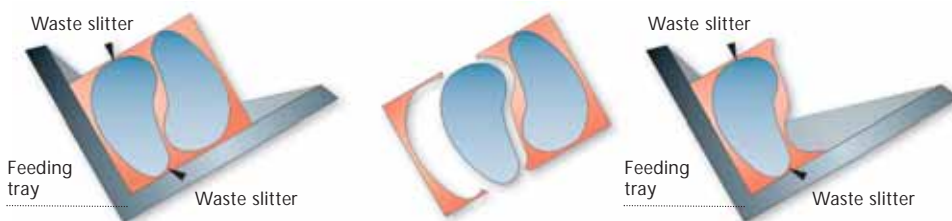

DIES with perfect cutting geometry and long service life, made of normal steel, aluminium HSS steel or aluminium tungsten carbide are manufactured in the standard heights of 60 or 70 mm. The die maker needs documentation like product samples, films, dimensional drawings or transmissions of files (dxf, dwg, eps and others). The dimensions should indicate a tolerance. The thickness of the die back, the grinding angle and the inner chamfer are material-dependent. Waste slitters, milled slots, clamping surfaces or guide surfaces can be attached by the die maker upon request.

A cutting die with bores for screwing on waste slitters can also work with separately-installed waste slitters. In this case one or more slitters are fixed into the clamping arms of the BUSCH die-cutting machine. Waste slitters and holders are supplied as standard accessories. The number of slitters varies according to the material, size and contour of the product to be die-cut. The slitters can be fixed flexibly, giving the ability to reach any required point.

Special material like embossed paper, PP or PE foil needs to be die-cut with counter-pressure.

The necessary counter-pressure matrix made of plastics or aluminium is also manufactured by the die maker, exactly matching the die form.

Cutting dies



Types of cutting dies



The image shows a cutting die for the full-cut of the complete outer label contour. The waste slitter is installed into one of the adjustable clamping arms of the machine, positioned at the most suitable point for slitting the waste.



The example illustrates a die for cutting the complete outer contour (full-cut) of playing cards. The waste slitters are screwed on to the die.



The neck label shows a full-cut of the shape. The die works with screwed on waster slitters or with separately fitted slitters.

This is an example for cutting a deckle edge. The die is manufactured for the full cut of the label shape with two screwed on waste slitters.



A brochure cutting die with two screwed on waste slitters and two optional scribing slitters for the back of the booklet, fitted at the bottom on the guide surface. The die-cut is not made at the guide surface, as the brochure (or for example a children's booklet) is stitched or glued on this side.



This example shows a die for the full-cut of a plastic foil in-mould label. The cut is made using counter-pressure. The counter-pressure matrix – shown in the middle – exactly matches the die form. The movable matrix inside the die uses compressed air to supply the counter-pressure during the cutting process.

Model overview

Die-cutting machine A, A+P, AL

For smaller runs, especially for labels



Die-cutting machine B, B+P

For larger cutting sizes with
increased punching power



Die-cutting machine BL, BLS

For large sizes, with high punching
power and light barrier activation
of the cutting stroke



Die-cutting machine CL

For large-sized products
up to 330 x 380 mm



Die-cutting machine A, A+P and AL

Series A is used for small and medium runs, mostly for labels. These models offer a cutting size up to 180 x 180 mm.

Machine construction and function of the three models are identical except for the method of releasing the cutting stroke, as specified below. The machines are supplied with 5 adjustable clamping arms, waste slitters and holders which are fitted into the clamping arms, thus being able to reach any required position for slitting the waste.

Once the stack of material is inserted the cutting stroke is activated by different functions according to the machine model.

Activation of the cutting stroke:

A by manual closure of the protective door, secured by auto-controlled limit switches. The door opens automatically when the punching ram runs backwards.

A+P by pneumatic closure of the protective door after pressing a push-button on the control panel. The function is secured by auto-controlled limit switches. The door opens automatically when the punching ram runs backwards.

AL by activating the electronic light barrier. The cutting stroke is activated automatically after the operator has inserted the stack of material and his/her hand has been withdrawn from the punching section. The throughput of the machine increases due to the quicker feeding sequence. The machine stops if the operator breaks the light-barrier during the cutting process or during the backward run of the punching ram. The die-cutter therefore has no protective door.

The finished products are pushed onto the delivery tray for removing.



Die-cutting machine A

The pneumatic counter-pressure unit GD-A, suitable for all A series machines is easy to fit onto the tray support instead of the delivery tray. The protective hood remains in place. Refitting will take approx. 10 minutes.

The die is especially manufactured for counter-pressure cutting with a movable matrix of plastics or aluminium inside the die. The counter-pressure unit is connected to a compressed air supply. The material is placed in front of the die with the projecting matrix and is held vertically in the die for stabilizing during the hydraulic cut. When the ram reaches the end of its stroke, the finished material is pushed back into the feeding tray by the pneumatic counter-pressure cylinder, from where it is removed. This reduces the throughput of the machine by approx. half.

See also page 7 (Description of die-cutting with counter-pressure)



Fitted counter-pressure unit



AL with counter-pressure unit

Die-cutting machine A, A+P, AL

Model		A	A+P	AL
Max. die-cut size	mm	180x180	180x180	180x180
Min. die-cut size	mm	17 x 17 ¹⁾	17 x 17 ¹⁾	17 x 17 ¹⁾
Min. die-cut size with counter-pressure	mm	30 x 30	30 x 30	30 x 30
Max. diameter for circular products	mm	180	180	180
Max. stack height (height of cutting die 60 mm)	mm	200	200	200
Die-cutting pressure	kg	2.500	2.500	2.500
Die-cutting strokes ²⁾	per min	11	13	15
Machine output ²⁾ (inserting 1.000 sheets/80gsm)	sheets/h	660.000	780.000	900.000
Weight	kg	570	575	575

¹⁾ One measure can be reduced to 10 mm with reinforced die back

²⁾ Max. achievable output. Die-cutting with counter-pressure reduces the output approx. by half

Counter-pressure unit GD-A

Model		GD-A
for die-cutting machines A, A+P, AL		
Pneumatic connection:		
Max. compressed air requirements	nl/min	12
Counter-pressure, adjustable	bar	0-8 (250 kg)
Measurements: Length x width x height	mm	315 x 60 x 325
Weight	kg	10

The use of a counter-pressure unit is recommended

- when die-cutting embossed paper and plastics (PP or PE foil) for small-sized inmould labels and similar articles – to minimise stretching or movement of the material during the cutting process
- when cutting tempered and varnished aluminium foil, e.g. for neck labels
- where tight tolerances are required



Machine series B offers a larger cutting size up to 230 x 230 mm and greatly increased punching power. All types of material, especially plastics, can be cut. The machines are used for small and medium runs.



Die-cutting machine B and B+P

The compact and robust design reflects the increased punching power. The construction and function of both models are identical except the method of releasing the cutting stroke, as specified below.

The machines are supplied with 5 adjustable clamping arms, waste slitters and holders which are fitted into the clamping arms – thus being able to reach any required position for slitting the waste. The number of waste slitters needed is determined by the material, size and contour of the product to be die-cut.

Once the stack of material is manually inserted the cutting stroke is activated by different functions according to the machine model.

Activation of the cutting stroke:

B by manual closure of the protective door, secured by auto-controlled limit switches. The door opens automatically when the punching ram runs backwards.

B+P by pneumatic closure of the protective door after pressing a push-button on the control panel. The function is secured by auto-controlled limit switches. The door opens automatically when the punching ram runs backwards.

The finished products are pushed onto the delivery tray for removing.



Die-cutting machine B+P

The pneumatic mobile counter-pressure unit for model B or B+P is easy to fit to the die-cutter in place of the delivery tray. The trolley facilitates the removal and storage of the delivery tray which can be refitted quickly for jobs without counter-pressure. Changeover time approx. 20 minutes.

The die is especially manufactured for counter-pressure cutting with a movable matrix of plastic or aluminium inside the die. The counter-pressure unit is connected to a compressed air supply. The material is placed in front of the die with the projecting matrix and is held vertically in the die for stabilizing during the hydraulic cut. When the ram reaches the end of its stroke, the finished material is pushed back into the feeding tray by the pneumatic counter-pressure cylinder, from where it is removed. This reduces the throughput of the machine by approx. half.

See also page 7 (Description of die-cutting with counter-pressure)



B+P with counter-pressure unit and waste conveyor (see ancillary equipment)

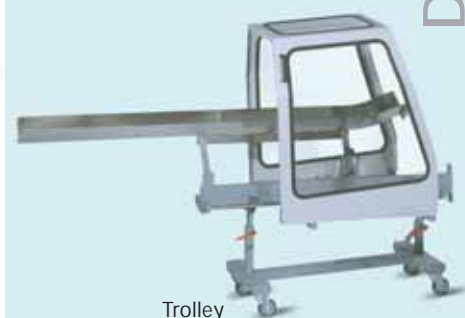

Trolley

Die-cutting machine B, B+P

Model		B	B+P
Max. die-cut size	mm	230 x 230	230 x 230
Min. die-cut size	mm	10 x 10	10 x 10
Min. die-cut size with counter-pressure	mm	30 x 30	30 x 30
Max. diameter for circular products	mm	235	235
Max. stack height (height of cutting die 60 mm)	mm	170	170
Die-cutting pressure	kg	5.700	5.700
Die-cutting strokes ¹⁾	per min	11	13
Machine output ¹⁾ (inserting 1.000 sheets/80gsm)	sheets/h	660.000	780.000
Weight	kg	855	860

¹⁾Max. achievable output. Die-cutting with counter-pressure reduces the output approx. by half

Counter-pressure unit GD-1

Model for die-cutting machines B, B+P		GD-1
Pneumatic connection:		
Max. compressed air requirements	nl/min	55
Counter-pressure, adjustable	bar	0-8 (630 kg)
Measurements: Length x width x height	mm	1.100 x 610 x 1.380
Weight	kg	305

The use of a counter-pressure unit is recommended

- when die-cutting embossed paper and plastics (PP or PE foil) for small-sized in mould labels and similar articles to minimise stretching or movement of the material during the cutting process
- when cutting tempered and varnished aluminium foil, e.g. for neck labels
- where tight tolerances are required

Two powerful die-cutters with high productivity for larger formats, equipped with light barrier activation of the cutting stroke. The machines are used for medium and large-scale jobs and process materials and articles of all types. The maximum cutting size for model BL is up to 220 x 260 mm, for model BLS is up to 230 x 320 mm.

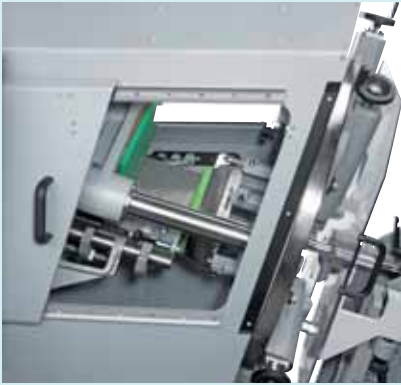

Sliding door on the rear



Control panel

Die-cutting machine BL and BLS

The robust machine design reflects the increased punching power. The hydraulic equipment is integrated within the machine body. The construction and function of both models are identical except for the size of the machine body – due to the variations in cutting size.

Activation of the cutting stroke:

By activating the electronic light barrier. The cutting stroke is activated automatically after the operator has inserted the stack of material and his/her hand has been withdrawn from the punching section. The machine stops if the operator breaks the light barrier during the cutting process.

The machines are supplied with 5 (BL) or 6 (BLS) adjustable clamping arms, waste slitters and holders which are fitted into the clamping arms, thus being able to reach any required position for slitting the waste. The number of waste slitters needed is determined by the material, size and contour of the product to be die-cut.

The sliding door on the rear of the machine facilitates fitting of the die and the waste slitters. This offers access to the cutting section from both the control and rear side.

The die-cutters are most commonly used for cutting contours of large-sized labels, brochures, children's booklets, credit and loyalty cards, for die-cutting in a two-up system (see *production methods page 8-9*), and for counter-pressure cutting with special material for inmould labels. The machines process high volumes of all types of products.



Die-cutting machine BL

The pneumatic mobile counter-pressure unit for model BL or BLS is easy to fit to the die-cutter in place of the delivery tray. The trolley facilitates the removal and storage of the delivery tray which can be refitted again quickly for jobs without counter-pressure. Changeover time approx. 20 minutes.

The die is especially manufactured for counter-pressure cutting with a movable matrix of plastic or aluminium inside the die. The counter-pressure unit is connected to a compressed air supply. The material is placed in front of the die with the projecting matrix and is held vertically in the die for stabilization during the hydraulic cut. When the ram reaches the end of its stroke, the finished material is pushed back into the feeding tray by the pneumatic counter-pressure cylinder, from where it is removed. This reduces the throughput of the machine by approx. half.

See also page 7
(Description of die-cutting with counter-pressure)



BLS with counter-pressure unit

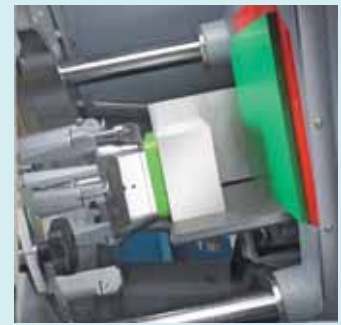

Feeding tray with stack of material



Trolley

Die-cutting machine BL, BLS

Model		BL	BLS
Max. die-cut size	mm	220 x 260	230 x 320
Min. die-cut size	mm	15 x 15 ¹⁾	20 x 20 ¹⁾
Min. die-cut size with counter-pressure	mm	30 x 30	30 x 30
Max. diameter for circular products	mm	250	260
Max. stack height (height of cutting die 60 mm)	mm	190	190
Die-cutting pressure	kg	5.700	5.700
Die-cutting strokes ²⁾	per min	18	16
Machine output ²⁾ (inserting 1.000 sheets/80gsm)	sheets/h	1.080.000	960.000
Weight	kg	1.350	1.450

¹⁾ One measure can be reduced to 10 mm with reinforced die back

²⁾ Max. achievable output. Die-cutting with counter-pressure reduces the output approx. by half

Counter-pressure unit GD-2

Model for die-cutting machines BL, BLS		GD-2
Pneumatic connection:		
Max. compressed air requirements	nl/min	55
Counter-pressure, adjustable	bar	0-8 (630 kg)
Measurements:: Length x width x height	mm	1.114 x 680 x 1.300
Weight	kg	288

- The use of a counter-pressure unit is recommended
- when die-cutting embossed paper and plastics (PP or PE foil) for inmould labels and similar articles to minimise stretching or movement of the material during the cutting process
 - when cutting tempered and varnished aluminium foil
 - for large-sized labels of difficult material
 - for 4-sided cutting of folded sheets (e.g. sheet separating for diaries)
 - where tight tolerances are required

An extremely robust die-cutter with increased punching power for large formats up to 330 x 380 mm, with light barrier activation for the cutting stroke. The machine is mainly used for counter-pressure cutting.



Sliding door on the rear



CL with delivery tray



Trolley with delivery tray

Die-cutting machine CL

The machine design is very similar to models BL und BLS, adapted for the extremely high punching power and the larger cutting size.

Activation of the cutting stroke:

By activating the electronic light barrier. The cutting stroke is activated automatically after the operator has inserted the stack of material and his/her hand has been withdrawn from the punching section. The machine stops if the operator breaks the light barrier during the cutting process.

The machine is supplied with 5 adjustable clamping arms, waste slitters and holders which are fitted into the clamping arms, thus being able to reach any required position for slitting the waste. The number of waste slitters needed is determined by the material, size and contour of the product to be die-cut.

The sliding door on the rear of the machine facilitates the fitting of the die and the waste slitters. This offers access to the cutting section from the control and rear side.

The die-cutter, connected with a counter-pressure unit, is most commonly used for cutting contours of large-sized in mould labels and similar products made of plastics like PE or PP-foil.

For large-sized products of paper, board or PVC, where no counter-pressure is needed, the die-cutter is fitted with a delivery tray in place of the counter-pressure device. Changeover time approx. 30 minutes.



CL with counter-pressure unit and waste conveyor

The pneumatic mobile counter-pressure unit is fitted to the die-cutter and to a compressed air supply. The die is especially manufactured for counter-pressure cutting with a movable matrix of plastic or aluminium inside the die. The material is placed in front of the die with the projecting matrix and is held vertically in the die for stabilizing during the hydraulic cut. When the ram reaches the end of its stroke, the finished material is pushed back into the feeding tray by the pneumatic counter-pressure cylinder, from where it is removed.

See also page 7
(Description of die-cutting with counter-pressure)



CL with counter-pressure unit

The use of a counter-pressure unit is required

- when die-cutting plastics like PP or PE foil for large-sized inmould labels and similar articles. Working with the counter-pressure unit minimises stretching or movement of the material during the cutting process.

Die-cutting machine CL

Model	CL	
Max. die-cut size	mm	330 x 380
Min. die-cut size	mm	80 x 100
Min. die-cut size with counter-pressure	mm	70 x 140
Max. diameter for circular products	mm	365
Max. stack height (height of cutting die 90 mm)	mm	210
Die-cutting pressure	kg	11.700
Die-cutting strokes ¹⁾	per min	9
Machine output ¹⁾ (inserting 1.000 sheets/80gsm)	sheets/h	540.000
Weight	kg	2.600

¹⁾ Max. achievable output. Die-cutting with counter-pressure reduces the output approx. by half

Counter-pressure unit GD-3

Model for die-cutting machine CL	GD-3	
Pneumatic connection:		
Max. compressed air requirements	nl/min	65
Counter-pressure, adjustable	bar	0-8 (630 kg)
Measurements: Length x width x height	mm	1.335 x 830 x 1.280
Weight	kg	400

Ancillary equipment

The following ancillary equipment is offered as an option.

BUSCH Waste conveyors

The conveyors are used for the removal of cutting waste into containers. Available conveying heights: 110, 145 and 175 cm. The conveyor is positioned laterally under the waste chute, on the left or right-hand side of the die-cutter or at right-angles to the machine, depending on the space requirements.

Essential – cost-saving – quick and clean.

Please visit our website

www.buschgraph.de -> Products -> Conveying



Equipment for bevelled edge cutting

A newly-designed device enables the bevelled edge-cutting of a standard printed pad or sticky note pad. The bevelled edge may be straight or formed. The pneumatic device is fitted to the punching ram of the die-cutter.

See also page 8

(Die-cutting pads with bevelled edge)



Equipment for cutting in a two-up system

The equipment provides savings on material and guillotining time. The pre-cut sheet contains two labels, one of which is turned through 180°. This is especially useful for shaped detergent or food labels. The image on the left shows the holding device onto which the second, uncut, pile of labels is conveyed, from where it is manually removed for the second cutting step. For this cutting method we recommend our machine models BL or BLS.

See also a detailed

description on page 9



Holding down device

If the pre-cut sheets are long and narrow or if they have been varnished they may lift up in the feeding tray during the cutting process; then an additional guide surface is obtained with the help of the holding down device. Cutting tolerances are thus minimised. This device can easily be inserted into one of the clamping arms.



BUSCH Table banding machines

For banding products after the die-cutting process

The thousands of machines sold worldwide mark the success of these versatile table banders. The machines handle both simple and difficult work with ease in so many locations. Products are banded with Kraft paper or with PP-foil in tape widths of 20–50 mm according to the machine model. The maximum measurements of products to be banded are for model TB 26: width 260 mm (for foil banding 180 mm), height 150 mm; for model TB 39: width 390 mm, height 200 mm.

The table banders are supplied with our without a mobile large reel stand, recommended for high volume production. The stand height is easily adjustable. The large reel stand can be used for both models TB 26 and TB 39.

Please visit our website www.buschgraph.de -> Products -> Banding



TB 26

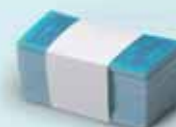

TB 26
with large reel stand



TB 39
with large reel stand



Model series		Die-cutting machine A, A+P and AL		
Model		A	A+P	AL
Max. die-cut size	mm	180 x 180	180 x 180	180 x 180
Min. die-cut size	mm	17 x 17 ¹⁾	17 x 17 ¹⁾	17 x 17 ¹⁾
Min. die-cut size with counter-pressure	mm	30 x 30	30 x 30	30 x 30
Max. diameter for circular products	mm	180	180	180
Max. stack height (height of cutting die 60 mm)	mm	200	200	200
Die-cutting pressure	kg	2.500	2.500	2.500
Die-cutting strokes ²⁾	per min	11	13	15
Machine output ²⁾ (inserting 1.000 sheets/80gsm)	sheets/h	660.000	780.000	900.000
Compressed air requirements (for machines with pneumatic closure of protective door)	nl/min	–	4	–
Oil tank capacity	l	80	80	80
Number of clamping arms (as standard)		5	5	5

Space requirements				
Lenght with delivery tray	mm	2.550	2.550	2.550
Lenght with counter-pressure unit	mm	2.260	2.260	2.260
Width	mm	770	770	770
Height	mm	1.370	1.370	1.370
Weight	kg	570	575	575

¹⁾ One measure can be reduced to 10 mm with reinforced die back

²⁾ Max. achievable output. Die-cutting with counter-pressure reduces the output approx. by half

Subject to modifications.



Die-cutting machine B, B+P		Die-cutting machine BL, BLS		Die-cutting machine CL
B	B+P	BL	BLS	CL
230 x 230	230 x 230	220 x 260	230 x 320	330 x 380
10 x 10	10 x 10	15 x 15 ¹⁾	20 x 20 ¹⁾	80 x 100
30 x 30	30 x 30	30 x 30	30 x 30	70 x 140
235	235	250	260	365
170	170	190	190	210 (height of cutting die 90 mm)
5.700	5.700	5.700	5.700	11.700
11	13	18	16	9
660.000	780.000	1.080.000	960.000	540.000
-	4	-	-	-
120	120	190	200	350
5	5	5	6	5
3.020	3.020	3.000	3.020	3.330
2.300	2.300	2.270	2.280	2.760
840	840	1.040	1.090	1.730
1.630	1.630	1.470	1.520	1.840
855	860	1.350	1.450	2.600



We supply quality.
Worldwide

Die-Cutting Machines

Banding Machines

Waste Conveyors

Pile Turners

Ink Mixers

Peripherals for Cutting Systems

Guillotines 

Gerhard Busch GmbH
Brookdamm 28
D-21217 Seevetal
Tel.: +49 (0)40 769159-0
Fax: +49 (0)40 769159-33
info@buschgraph.de
www.buschgraph.de

BUSCH 
GRAPHISCHE
MASCHINEN