

BEST OSAKO SADDLE STITCHERS

The Next Generation of Performance-Built Automation



BEST OSAKO SADDLE STITCHERS *Since 1950*



Best Graphics Group is the exclusive North American distributor for Osako Saddle Stitchers. Manufactured in Japan, Osako has a 50+ year history of producing world-class Saddle Stitching systems, with over 3,000 installations worldwide and over 400 in North America to date. Osako is the only stitcher manufacturer whose sole focus is manufacturing Saddle Stitching technology... with unmatched affordable automation, flexibility, optimal footprints, and much higher 'on the floor' productivity

Known for their durability, ease of operation and high level of automation, Osako now offers three performance levels:

- **Tener Alpha** 12,000 cph
- **Estar Alpha** 10,000 cph
- **Micro** 9,000 cph

All Osako models feature proven automation platforms that minimize set up and maximize the highest production speeds. Osako offers the most affordable automation in the industry with as little as 10-minute makereadies. In many cases, Osako Stitching systems can double production speeds and cut makereadies in half.

The Tener Alpha offers full automation in our largest format, up to 18.9" spine length. The Estar Alpha provides semi-automated makeready control in a mid-size format with computer setting of stitch heads & clinchers to chain rail. The Micro includes key 'Alpha' level automation in a space saving design. Heavy duty and affordable, the Micro provides the highest productivity of any small format stitcher available. All Osako Stitchers come with an Industry-Leading three-year parts warranty.

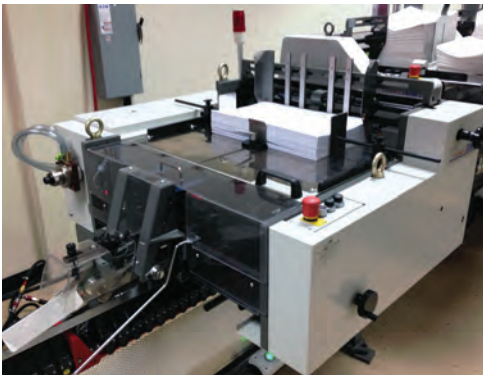

Cover feeder –
*unique registration
and fold bar design*



Reduced Makeready – 4th and
5th knife changeover in 15 minutes



Rotary feeders – toolless setup, backstop
and vacuum timing adjustable on-the-fly



Rotary feeders –
*tilt back/tilt forward
feature with
individual pumps*

**Wireless remote
control** – aids setup



Touch screen – quick
setup and diagnostics

Product design subject to change without notice.



Tener Alpha 12,000 cph
Large format (up to 18.9" spine)
Fully automated makeready



**Estar Alpha
10,000 cph**
Mid-size format (16.9" - 18.5"* spine)
Semi-automated makeready



Micro 9,000 cph
Small format
(up to 14.96" spine)
Semi-automated
makeready

TYPICAL FLOOR PLANS

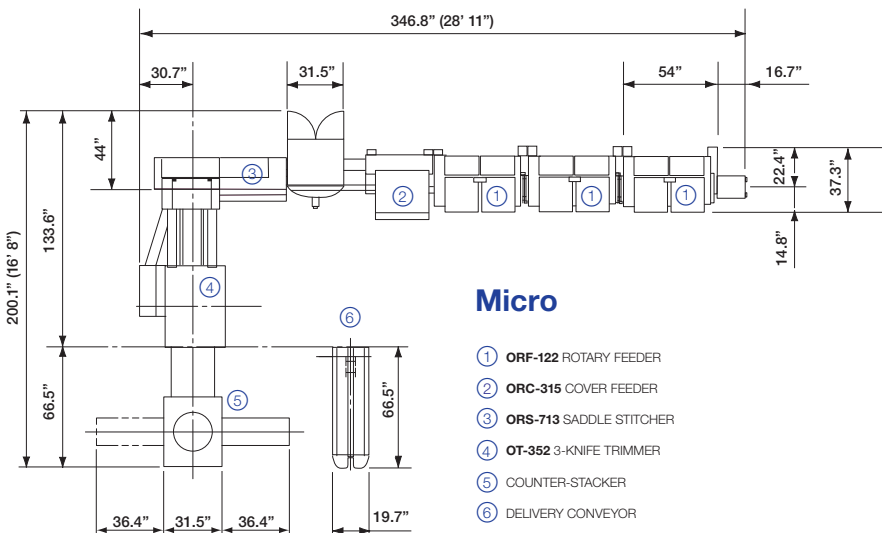
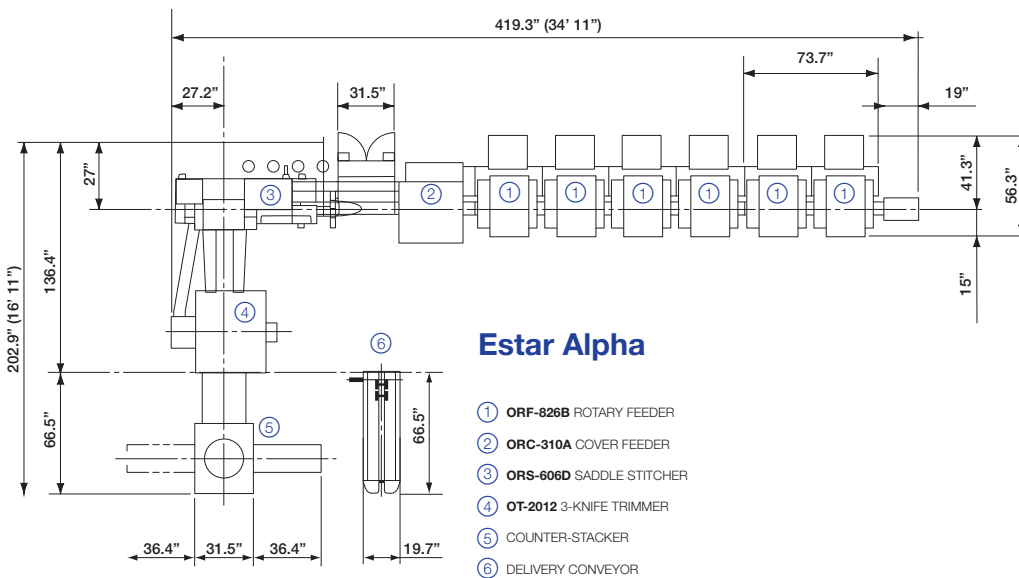
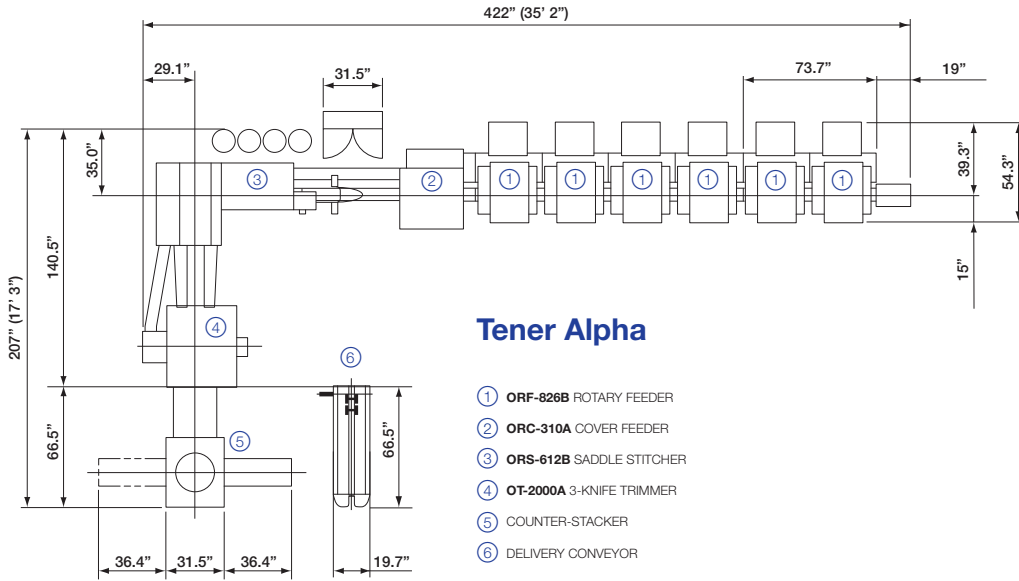

Ask about ...

Our industry-leading
Three-Year Warranty
on all Osako Stitchers and our
**Unlimited
Phone Support**

“What’s really nice about the Osako is that we can perform twice the amount of work in one shift that we used to... You helped us analyze our equipment needs and costs vs. payback. You helped us plan financing and installation. You did a lot more for us than sell.”

JK Creative Printers, IL

“We are absolutely thrilled with the stitcher and your customer service, and I now understand how you have maintained 100% Customer Loyalty. We only plan to look at Osako for our future needs.”

Tobay Printing, NY

“Our new Osako is as user-friendly as anything out there.... We’ve had no service issues... I think Osako is just as good and as productive as the No. 1 brand and for a lot less money... My guys are trained on the Osako and they love it... I’ll take an Osako over whatever else is out there anytime.”

Lithographix, CA

X = standard O = option

FEATURES

	Tener Alpha	Estar Alpha OT-323B	Estar Alpha OT-2012	Micro
Computer				
Touch Screen Control Monitor	X	X	X	X
Automatic Format Presetting	X			
Computer Guided Make Ready	X	X	X	X
Automatic Stitch Head Positioning	X	X	X	X
Downstream Inhibit	X	O	O	
Sequential Start & Stop	X	X	X	
Stitcher				
Wireless Remote Control	X			
AutoSet Digital Caliper	X			
Mechanical Caliper	X	X	X	X
Skewed Signature Detector	X	X	X	X
Missing Stitch Detector	X	X	X	X
Automatic Lubrication System	X	X	X	
Feeders				
Pneumatic Timing	X	X	X	
Timing 1:1 & 2:1	X	X	X	X
Individual Pumps	X	X	X	
Tilt Design	X	X	X	X
High & Low Folio Gripper Opening	X	X	X	
Vacuum Signature Opening	X	X	X	X
Cover Feeder With Register, Fold Bar System	X	X	X	X
Vacuum Release Timing Adjustable On Fly	X	X	X	
Trimmer				
Fully Automatic	X			
Semi Automatic	O	X	X	X
Face First Trim	X	X	X	
Face Last Trim	O	O	O	X
4 th & 5 th Knife Assembly	O	O	O	O
6 th & 7 th Knife Assembly	O			
Automatic Lubrication System	X	X	X	



* Specifications subject to change without notice

OPTIONAL ACCESSORIES (All Models)

- Shingle Delivery Conveyor with Batch Kicker
- Counter Stacker
- Signature Recognition System
- Loop Stitch Heads
- Narrow Stitch Heads
- Blower Waste Removal
- Conveyor Waste Removal
- Fenimore 1, 3, 5, 7 Hole Punch
- Fenimore Calendar Punch

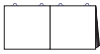

TECHNICAL DATA

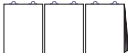
TECHNICAL DATA		Tener Alpha	Estar Alpha OT-323B	Estar Alpha OT-2012	Micro
Output (cycles per hour)		12,000	10,000	10,000	9,000
Formats (width or drop x spine length)	Range				
Untrimmed	Maximum	12.6" x 18.9"	12" x 16.9-18.5"*	12" x 17.4"	12.4" x 14.96"
	Minimum	3.74" x 3.94"	3.74" x 3.94"	3.74" x 3.94"	3.74" x 3.94"
Trimmed 	Maximum	12.2" x 18.5"	12" x 16.9-18.5"*	11.8" x 16.9"	12" x 14.32"
	Minimum	2.75" x 4.3***	2.75" x 4.3***	2.75" x 4.3***	2.75" x 5.83***
Trimmed Center Cut 	Maximum	12.2" x 9.25"	12" x 8.45-9.25"	11.8" x 16.9"	12" x 7.16"
	Minimum	2.75" x 4.92"	2.75" x 3.55"	3.78" x 5.06"	2.75" x 5.06"
Trimmed Punch Cut with 1/4" Knife width (single book size) 	Maximum	12" x 8.92"	12" x 8.33-9.13"*	11.8" x 8.4"	12" x 7.04"
	Minimum	2.75" x 4.8"	2.75" x 3.43"	3.78" x 4.93"	2.75" x 4.94"
Trimmed Punch Cut with 1/4" Knife width (single book size) 	Maximum	11.8" x 5.9"			
	Minimum	2.75" x 3.34"			
Product Thickness					
One Up Book		7/16"	7/16"	3/8"	3/8"
Multiple Up Books		1/4"	1/4"	3/16"	1/4"
Stitching Heads (supports up to)					
		8 Narrow 6 Standard 4 Loop	6 Narrow 4 Standard 3 Loop	6 Narrow 4 Standard 3 Loop	6 Narrow 4 Standard 3 Loop

* If maximum spine length is 18.5", width or drop is limited to 8.75"

** With tape arm/wheel assembly removed; extended stops



W222 N600 Cheaney Drive
Waukesha, WI 53186

Tel +1 (262) 522-3330

Fax +1 (262) 522-3280

Toll Free (800) 236-7603

Sales@BestGraphics.net

www.BestGraphics.net