

650 / 800 / 1100

SMARTFOLD CLASSIC

FOLDER-GLUERS

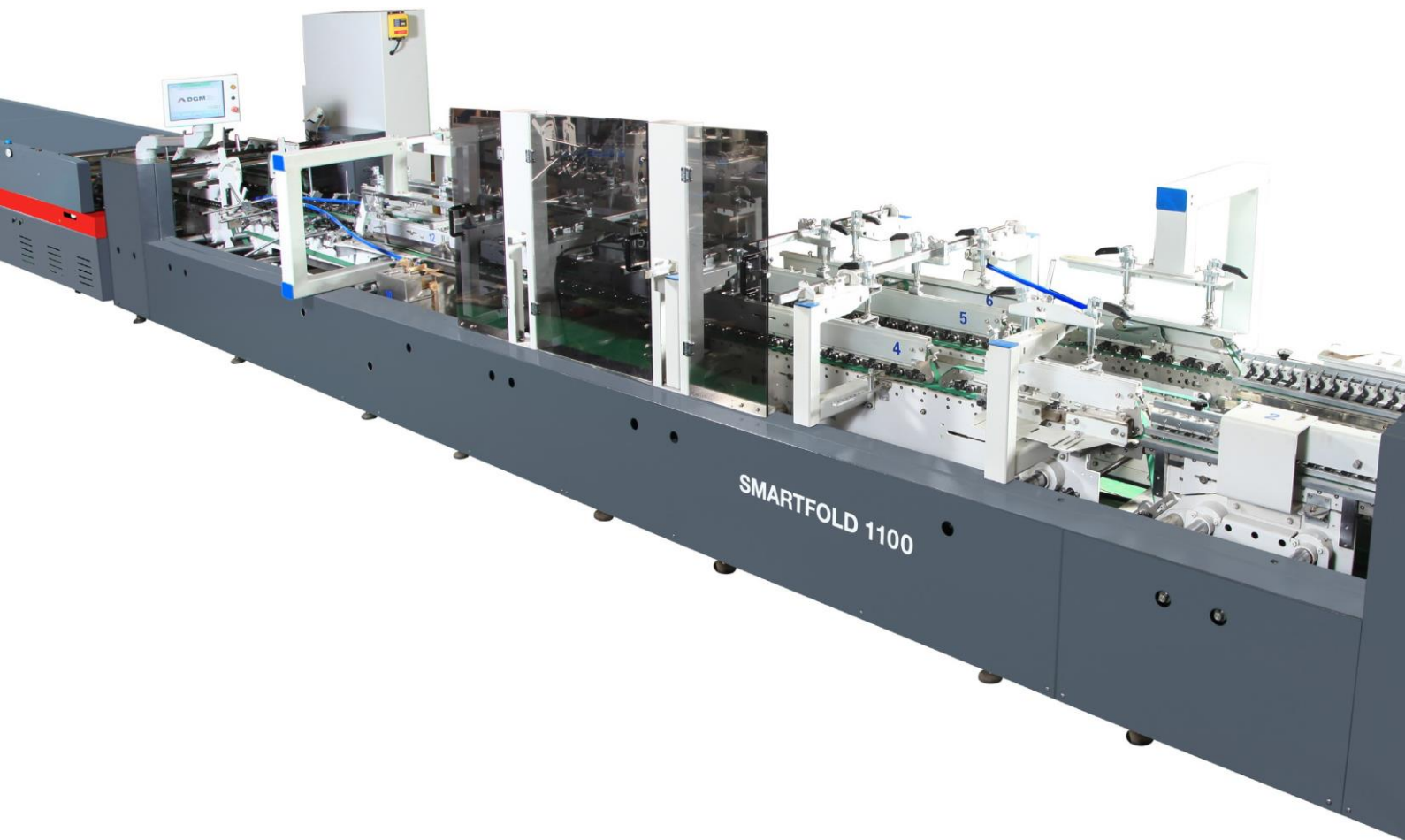

www.dgm-global.com

ADGM CARTON
CONVERTING
EQUIPMENT

SMARTFOLD CLASSIC Folder-gluer

650 / 800 / 1100

HIGH SPEED AUTOMATIC FOLDER GLUER

SMARTFOLD series it is specially indicated for the most demanding packaging companies, commercial printers and finishers. It is optimized to run small & medium sized boxes like the ones used in pharmaceutical or cosmetic industries. It is flexible to operate and it comes with a state-of-the-art technology and electronics. The standard version includes the accessories for straight line and crash lock bottom boxes. It is flexible and easy to operate.



MODELS

SMARTFOLD 650 PC

Suitable for straight-line, crash-lock bottom & double wall boxes.

SMARTFOLD 800 PC / 1100 PC

Suitable for straight-line, crash-lock bottom & double wall boxes.

SMARTFOLD 800 SL / 1100 SL

Suitable for straight-line, crash-lock bottom, double wall, 4 & 6 - corner boxes.

MATERIALS

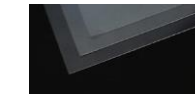

Plastic



Carton board



Corrugated board

BOXES

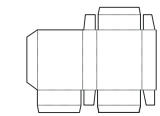

Straight line

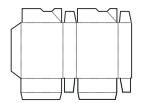

Lock - bottom box

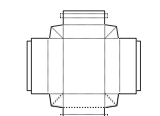

Double - wall Box

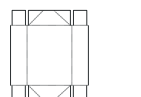

4 corner Box

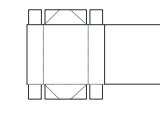

4 corner Box with Lid

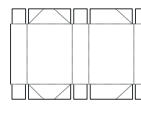

6 - corner box



COMPONENTS FOR ALL MODELS

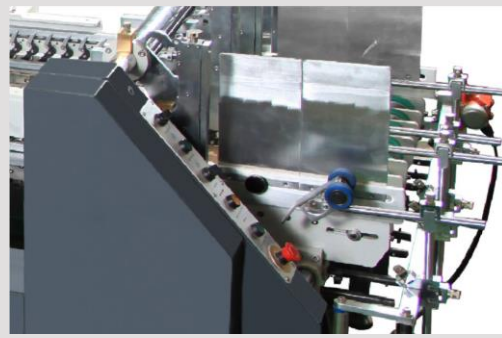

1

Feeder section

- Independent and motorized friction Feeder with variable speed.
- Adjustable electronic pile vibrator.
- Side feed gates fully adjustable to the width of the blank.
- Two adjustable front feed knives.

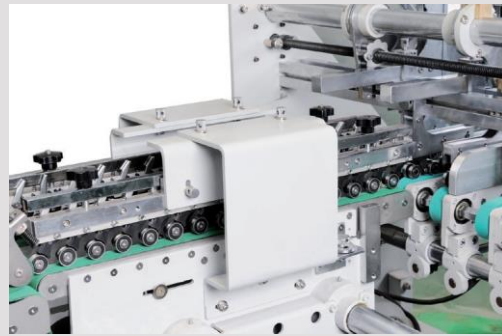

2

Side register section

- Independent section with an unparallel lower carrier that guides the box to a parallel handrail that allows a perfect blank alignment.



3

Pre-folding section

- Left hand glue flap pre-folder up to 180°.
- Third crease line pre-folder up to 135°.
- 1st and 3rd crease openers.

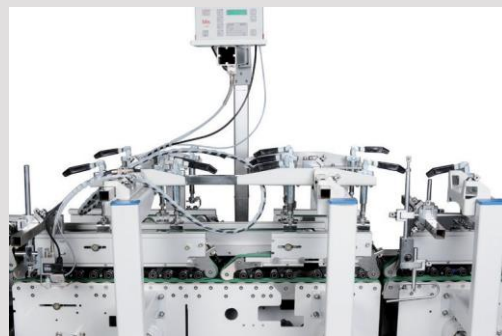

4

Crash lock bottom section

- Complete set of folding hooks and helices to fold the front flaps of the blank smooth and accurately.
- Set of accessories for B-type lock bottom.

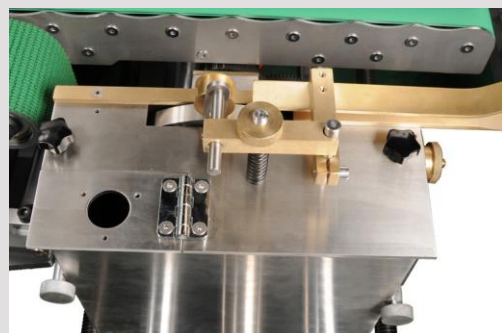

5

Lower gluing unit

- One lower (left side) gluing tank.
- Easy to remove and clean.
- Electronic upper gluing system by guns.



6

Folding and closing section

- Smooth and accurate folding of 2nd and 4th creases.
- Outer folding belts adjustable up to 180° with variable speed.
- Two upper and two lower carriers with 25 mm lower and 30 mm outer belts.
- Width-wise adjustable heavy-duty compression rollers (optional).



7

Trombone section

- Upper and lower drive mechanism for length adjustment.
- Equipped with automatic belt tension-adjusting system.
- Continuous and automatic box collection mechanism that ensures a neat transfer to the Press section, guaranteeing a well aligned flow.



8

Press section (Delivery section)

- Independent and motorized press section.
- Manual and Automatic mode (follow up).
- Upper section moves back and forward, allowing for different box length.
- 650: 3.5 meters total length with 2 meters effective pressure length.
- 800 / 1100: 5 meters total length with 3.5 meters effective pressure length.
- Pneumatic pressure adjustment.

COMPONENTS FOR 800/1100



9

4 and 6 - corner device

- Motorized and untimed electronic back folding system with intelligent servo motor technology.



10

Servo-motor of back folding device

- Two driven shafts allow a precise fold of the rear flaps. Easy to setup through the main touchscreen.

SMARTFOLD

650 / 800 / 1100



SCHEME SMARTFOLD 1100

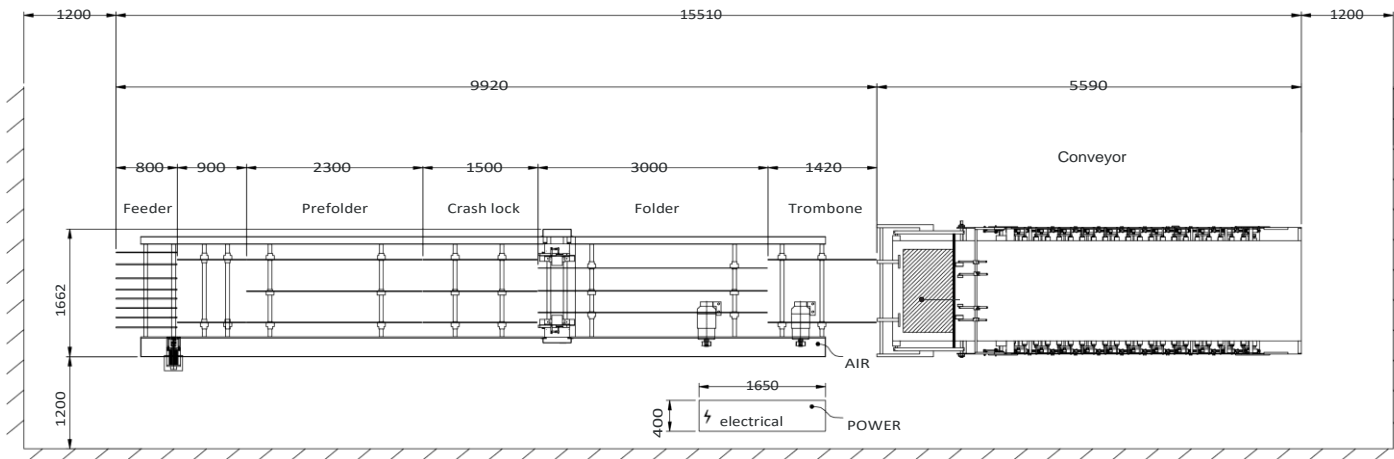

SPECIFICATIONS

SMARTFOLD	650	800	1100
Processed materials			
Carton board max.	800 g/m ²	800 g/m ²	800 g/m ²
Corrugated flute type	N, E & F	N, E & F	N, E & F
Capability			
Speed max.	400 m/min	400 m/min	400 m/min
Inching speed	20 m/min	20 m/min	20 m/min
Thickness of folded box max.	12 mm	20 mm	20 mm
Blank width	650 mm	800 mm	1100 mm
Dimensions & weight			
Length	13.23 m	PC 15.51 m SL 15.51 m	PC 15.51 m SL 15.51 m
Width	1.44 m	1.36 m 1.47 m	1.66 m 1.77 m
Height	1.3 m	1.4 m 1.4 m	1.4 m 1.4 m
Net Weight	6.5 Ton	7.2 Ton 7.5 Ton	7.8 Ton 8 Ton
Installation			
Electrical connected load	17 kW	22 kW 28 kW	22 kW 28 kW
Compressed air	6 bar	6 bar 6 bar	6 bar 6 bar
Air compressor capacity	10 m ³ /h	10 m ³ /h 10 m ³ /h	10 m ³ /h 10 m ³ /h
Air tank capacity	60 L	60 L 60 L	60 L 60 L

BOXES

	650	800	1100
 Straight line	A: 126 - 650 mm B: 100 - 500 mm E: 58 - 320 mm	A: 126 - 800 mm B: 60 - 800 mm E: 58 - 380 mm	A: 126 - 1100mm B: 100 - 800mm E: 58 - 530 mm
 Lock - bottom	A: 146 - 650 mm B: 110 - 500 mm E: 68 - 320 mm	A: 146 - 800 mm B: 110 - 800 mm E: 68 - 368 mm	A: 146 - 1100mm B: 110 - 800mm E: 68 - 518 mm
 Double - wall	A: 200 - 650 mm B: 100 - 500 mm D: 30 - 150 mm E: 80 - 530 mm	A: 200 - 800 mm B: 100 - 800 mm D: 30 - 150 mm E: 80 - 680 mm	A: 200 - 1100 mm B: 100 - 800 mm D: 30 - 150 mm E: 80 - 980 mm
 4 - corner		A: 140 - 750 mm B: 140 - 800mm H: 25 - 150 mm	A: 140 - 1050 mm B: 140 - 800mm H: 25 - 150 mm
 4 - corner with Lid		A: 250 - 800mm B: 140 - 800mm H: 25 - 150 mm	A: 250 - 1020 mm B: 140 - 800mm H: 25 - 150 mm
 6 - corner		A: 250 - 720 mm B: 140 - 800mm H: 25 - 150 mm	A: 250 - 1020 mm B: 140 - 800mm H: 25 - 150 mm

Huizhou De Gang Machinery Co., Ltd



USA & Canada exclusive distributor:

