



# G&K-VIJUK

## **FA 36/FA 45 FOLDERS**

*Easily fold miniature-size leaflets as well as commercial products on the same folder*



**A** FOLDING/ DEFLECTOR PLATES are made of durable chromium-plated steel for anti-static operation and long wear.

- Without removing the plate, a simple turn of the **ADJUSTMENT DIAL** determines whether it is a folding plate or a deflector plate.

- A gate-fold folding plate is also available.

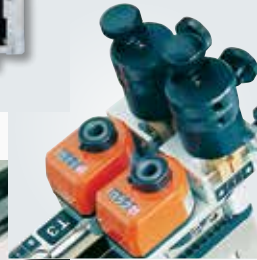

**H** BELT DRIVE SYSTEM is located on the outside of the machine (behind safety covers) for easy access.

- Universal joints ensure consistent, trouble-free operation.



**B** QUICK-SET FOLDING ROLLERS give you quick and easy setups and changeovers. Insert paper in the caliper device, and the roller pressure is automatically adjusted.

- Rotating on needle and axial bearings, the large diameter folding rollers allow you to fold heavier stock such as greeting cards.



**C** Heavy-duty adjustable SLITTING SHAFTS provide optimal perforating, slitting and scoring.

- Its quick-release feature reduces setup and changeover time.

# G&K V

## FA 36/FA 45

- GAIN VERSATILITY** with the capacity to fold the widest range of miniature-size to commercial-size products in one simple-to-operate folding system.
- SAVE TIME** with zero-makeready folding plates and automatic quick-set folding rollers.



**D** Continuous-load SAF FEEDER has air channels in the side rails that lift and separate the sheets, allowing the bottom-suction drum to draw the paper to the register table.

- An adjustable plate levels the feed edge of the paper to ease the transport of the paper onto the register table.
- When the side guide is adjusted to the paper width, the feed belt automatically centers to convey the sheets over the anti-static stainless steel register table in perfect registration.
- The gap between sheets of paper can be controlled to allow for gluing or other applications.
- The vacuum time on the sheets can be controlled to allow folding of stock as light as 27# offset.
- A single control automatically synchronizes the speed of both the feeder and folder for consistent production.





- G** CONTROL PANELS are ergonomically located.
- 1** The optional **MCS-106 PREDETERMINED COUNTER**, mounted over the SAF Feeder control panel, performs total and batch counting.
- The counter swivels to improve visibility to the operator.
  - It displays readouts of the total and batch counts and the current production speed by digital tachometer.
  - A 0- to 10-second delay can be set to pause the feeding process to create batches.
  - For batch counting with the vertical-stack delivery, you enter the number of pieces per batch to trigger the unit's ejector magnet which staggers pieces to mark batches.

- 2** **SAF CONTROL PANEL** has dual start buttons to guard against accidental starts while setting up.
- A single-sheet control allows sheets to feed into the folding unit at a reduced cycle to minimize setup time during changeovers.
  - The sheet length, the gap between sheets and the vacuum time on the sheets can be precisely programmed for trouble-free production.

# FOLDERS



**GUK FA 36 SAF FOLDER STATIONS I & II**



- E** This is the overview of the right-angle Station II folding unit showing the rust, static, and wear resistant alignment table.
- The stations can also be used in tandem for parallel folding.
  - Stations can have 2, 4, 6, or 8 folding plates.



- F** **VERTICAL-STACK DELIVERY UNIT** is optional for stacking folded products in an upright position for easy, orderly collection. (The machine comes with a standard Chute Shingle Delivery Unit.)
- It has an independent motor drive.
  - A built-in ejector magnet (kicker), controlled by the MCS-106 Predetermined Counter, staggers pieces to mark the batches.
  - Three widths—#KS-235: 9 1/4"; #KS-310: 12 1/4"; #KS-370: 14 5/8".
- 1** Optional **REMOTE CONTROL**, which can be hand held, allows the operator to start and stop production without returning to the main panel.

## FL 2 FLAT-PILE FEEDER option...

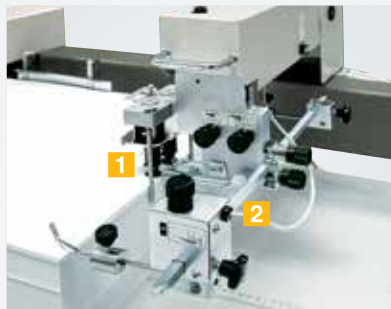

### A REAR SEPARATING FEED SYSTEM

- 1 Suction heads lift the sheets.
  - 2 Air blasts aerate and separate the sheets, making it possible to feed long or difficult-to-handle sheets.
- The REAR SEPARATING FEED SYSTEM is hinged to lift up and out of the way to make it easy to load the flat-plate feeder.

### B INFEED SECTION

- 3 The drum suction wheel, shielded by a safety cover, transfers the paper to the registration table leading to the folding rollers.
- 4 Optional side air blasts aid in the consistent transfer of the sheets.
- 5 A quick-set double-sheet detector ensures accurate feeding.

## AUTO FOLD-PLATE SETTING option ...

Computerized plate setting will save setup and production time. From a single control panel, you can pre-program all the folding plates for standard folding jobs, using 8 pre-set folding patterns (6), or specifically pre-program the plates for customized jobs. Micro adjustments can be made on-the-fly. Programs can be stored for recall.



## CUSTOMIZE with optional attachments...

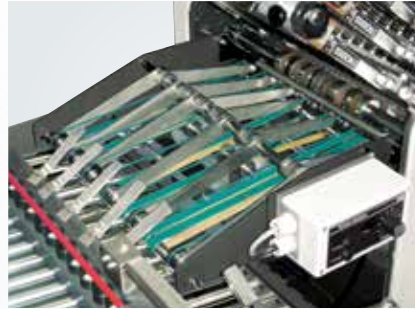

- ◀ Variable-speed TRANSFER UNIT aids in the transfer of the folded sheets from Station I to Station II and increases the accuracy of folding small pieces as well as extending the life of the rollers.



- ◀ MOBILE SHINGLE DELIVERY UNIT is for finished leaflets of more than 3 3/4" in height. Folded products are delivered shingled—one overlapping the other.
- It is height adjustable, tilt adjustable and has variable speed for better control of shingling the product. Two widths available: 13 3/4", 20 3/8".
- It is interchangeable with the Vertical-Stack Delivery Unit.



- ◀ EK 300 KNIFE FOLDING UNIT is for the final fold of leaflets that are too small to be handled in the side guide of the right angle station or too thick for buckle folding down to 1 1/4".
  - It has a built-in vertical delivery unit and an optional ejector magnet (kicker) for separating a preset number of finished pieces.
- (Specification sheet available.)*



- ◀ Heavy-duty commercial ZK 500/ZK 600 KNIFE FOLDING UNIT makes a final up or down cross fold.
  - It can also be used off-line for folding booklets, signatures (to up to 144 pages, depending on stock), or other special commercial folding applications.
- (Specification sheet available.)*

### Other optional equipment for efficiency...

- MCS-106 Predetermined Counter
- Continuous or batch counting devices
- Electro-magnetic double-sheet detector
- Variable-speed vertical-stack delivery unit
- Reversing vertical-stack delivery unit
- Vertical-stack delivery unit
- Gate-fold folding plate
- Gluing devices
- Pressing units
- Crimping device
- Strip cutting device

## GUK FA 36/FA 45 FOLDER SPECIFICATIONS

MODEL	FA 36	FA 45
Number of stations	1 to 3	1 to 3
Number of plates per station	2, 4, 6 or 8	2, 4, 6 or 8
Smallest fold Station I	5/8"	5/8"
Smallest fold Station II and III	3/4"	3/4"
SAF feeder max sheet size	14 <sup>3</sup> / <sub>16</sub> " x 25 <sup>1</sup> / <sub>2</sub> "	17 <sup>3</sup> / <sub>4</sub> " x 25 <sup>1</sup> / <sub>2</sub> "
SAF feeder min sheet size*	3 <sup>1</sup> / <sub>4</sub> " x 3 <sup>1</sup> / <sub>2</sub> "	3 <sup>1</sup> / <sub>4</sub> " x 3 <sup>1</sup> / <sub>2</sub> "
FL2 feeder max sheet size	14 <sup>3</sup> / <sub>16</sub> " x 33"	17 <sup>3</sup> / <sub>4</sub> " x 33"
FL2 feeder min sheet size	4 <sup>1</sup> / <sub>4</sub> " x 5 <sup>1</sup> / <sub>2</sub> "	4 <sup>1</sup> / <sub>4</sub> " x 5 <sup>1</sup> / <sub>2</sub> "
Production speed	500 ft./min.	500 ft./min.

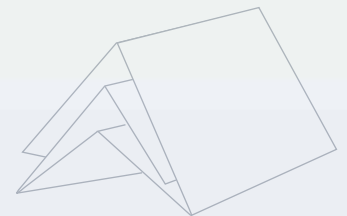
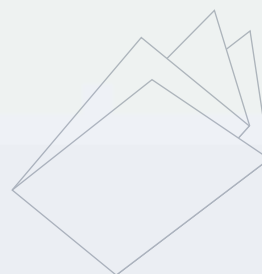
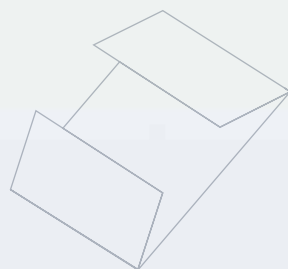
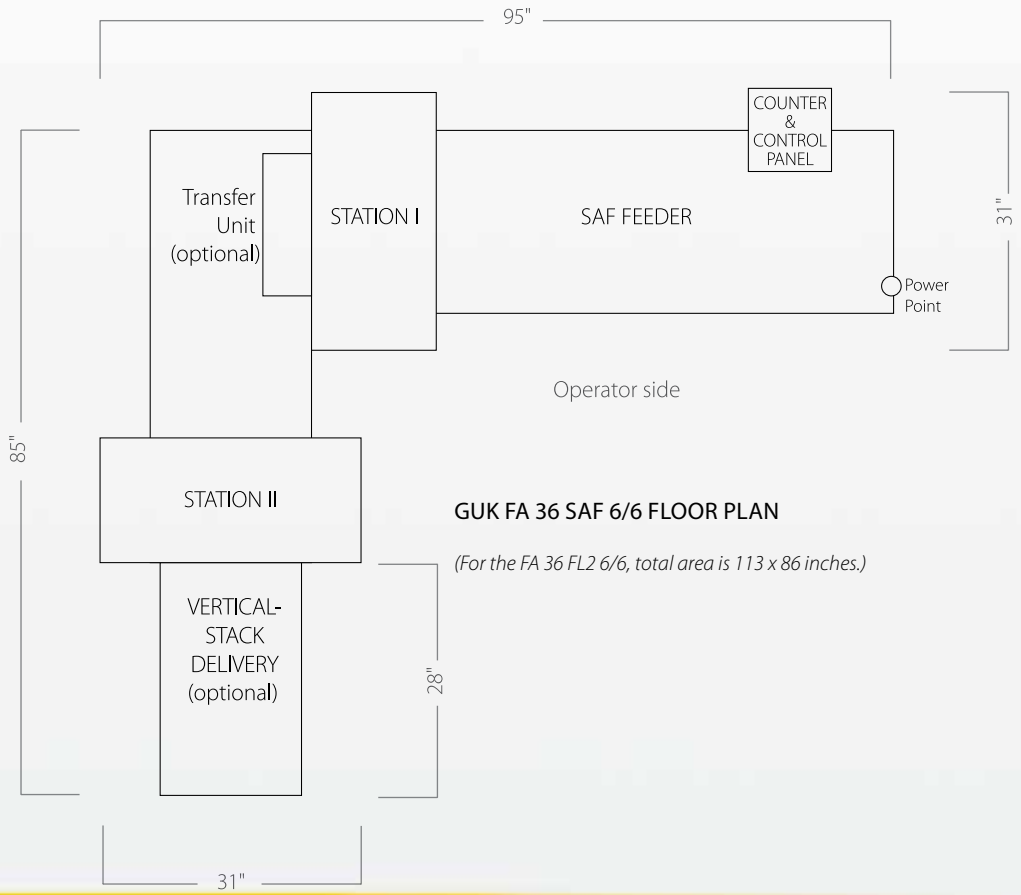
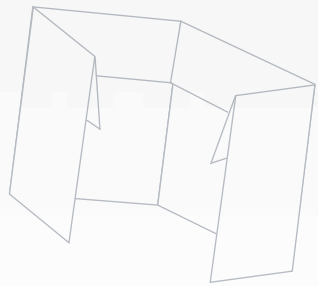
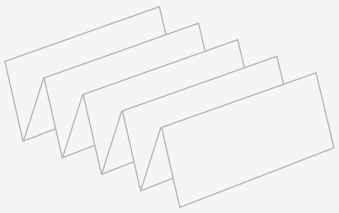
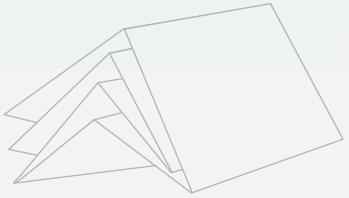

*W*e appreciate your interest in G&K–Vijuk International.

*For all your folding needs, G&K–Vijuk proudly offers high-quality equipment and excellent support and service.*

*Please contact us for...*

- *GUK Commercial Folders*
- *GUK Pharmaceutical, Miniature, and Packaging-Line Folders—sheet-fed and roll-fed*
- *G&K–Vijuk MV Outsert Systems*
- *GUK Mail-Producing Systems*
- *Auxiliary equipment to complement folding systems*
- *Specialty or customized folding equipment*
- *Spare parts for all G&K–Vijuk and GUK equipment*

G&K–VIJUK INTERN. CORP.  
715 Church Road, Elmhurst, Illinois 60126 • (630) 530-2203 FAX (630) 530-2245  
info@guk-vijuk.com • [www.guk-vijuk.com](http://www.guk-vijuk.com)

Partner of GUK–Falzmaschinen of Wellendingen, Germany  
Griesser & Kunzmann GmbH & Co. KG, D–78669 Wellendingen, Bahnhofstraße 4  
T: 011-49-7426-703-1 • F: 011-49-7426-703-333 • [info@guk-falzmaschinen.de](mailto:info@guk-falzmaschinen.de) • [www.guk-falzmaschinen.com](http://www.guk-falzmaschinen.com)

